

BladderScan™

BVI 3000

Bladder Volume Instrument

Short Operator's Manual

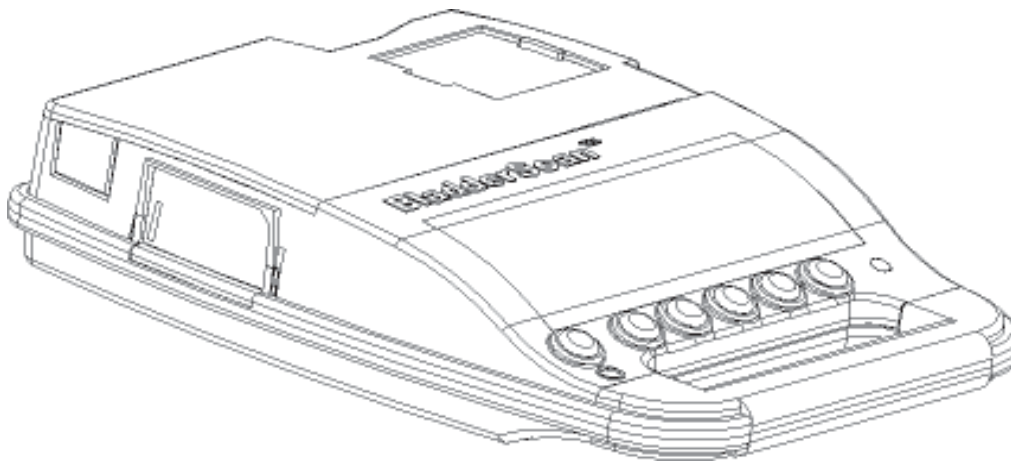

Corporate Headquarters
21222 30th Drive SE, Suite 120
Bothell, WA 98021-7012 USA
USA Only 1 800 331-2313
Phone 1 425 867-1348
Fax 1 425 883-2896

European Office
Lage Dijk-Noord 14
3401 VA IJsselstein
The Netherlands
Phone +31 30 68 70570
Fax +31 30 68 70512

Part No. 900-383-00-06EUR20031021SOM UK

Legal Statement

© 1998, Diagnostic Ultrasound Corporation. All rights reserved. This manual may not be copied without the express written consent of Diagnostic Ultrasound.

BladderScan™ and DxU are trademarks of the Diagnostic Ultrasound Corporation.

This instrument is protected by U.S. patent number 4,926,871 and 5,235,985. Other international patents pending.

DxU Europe Part No. 900-0383-00-60EUR200031021SOM UK

Table of Contents

Important Information	4
Installing the BVI 3000	4
Operating the BVI 3000	7
Quick Start	13
Proper Care and Maintenance	14
Trouble Shooting	15
Warranty	15
Safety and Performance Summary	16
BVI 3000 Components	17
Parts and Accessories	18
Technical Description	18
Declaration of Conformity	19

Important Information

Product Description

The **BladderScan™ BVI3000** bladder volume instrument is portable and battery operated, intended for the non-invasive measurement of urinary bladder volume. Utilizing a mechanical sector scanning transducer to provide cross sectional images of the bladder from twelve scanplanes, the machine automatically calculates the estimated bladder volume in milliliters and displays it on a screen.

Notice To All Operators

The BVI 3000 should be used only by individuals who have been trained and authorized by their physician or the institution providing care for the patient. All operators should read this Operator's Manual prior to using the BVI 3000. Do not attempt to operate the BVI 3000 until all instructions and procedures in this manual have been read and thoroughly understood. Failure to comply with instructions may compromise the performance of the instrument.

Biological Safety

The ultrasonic output power of the BVI 3000 is not user-adjustable and is limited to the minimum level necessary for effective performance. Data on acoustic output levels can be found in the "Technical Description" section of this manual.

Installing the BVI 3000

Connecting Scanhead

Connect the scanhead cable plug to the probe input socket toward the back of the instrument by aligning the tabs on the plug with the mating slots on the socket. Press straight in until there is a 'click.' To remove the plug, grasp the black plastic ring on the plug and pull straight out. Do not twist.

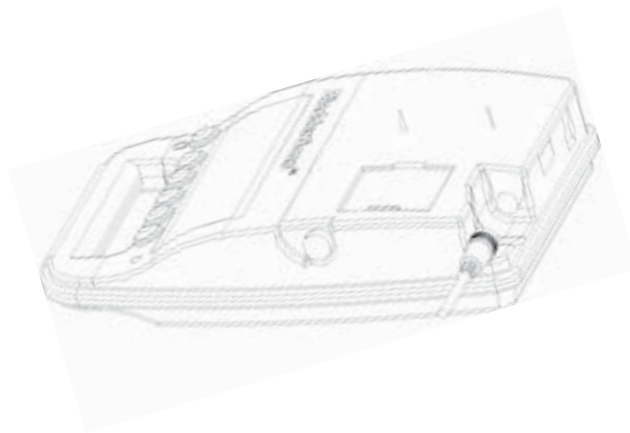

Battery Function

Plug the charger's power adapter into an electrical outlet. Slip the battery into the recess on the top of the battery charger. Batteries may be stored in the charger. Plugging and unplugging the charger causes no damage, whether the batteries are inserted or not.

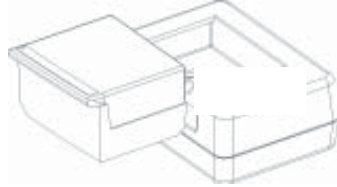

THE POWER ADAPTER AND BATTERY CHARGER

Check the color of the lights on top of the battery charger.

Continuous Green: When the battery is low on charge, the charger will begin with a fast charge. During fast charge, the green light is continuous. For a fully discharged battery, a fast charge takes about two to three hours.

Quickly Blinking Green: When a battery has about an 80% charge, the charger will 'top off' charging and the green light will begin to blink quickly. At this point the battery can be used in the scanner.

Amber Light: An amber light means the battery temperature is stabilizing before recharging can begin. This can happen when the battery is taken from a very cold or warm environment or if the battery is defective. If the light remains amber for over an hour, the battery is defective and must be replaced.

Slowly Blinking Green Light: If the green light blinks slowly upon inserting the battery it means that the battery level is too low for fast charging. It will trickle charge the battery until the battery level is high enough at which point it will begin fast charging.

When a battery has been properly charged, install it in the scanner using the following illustration.

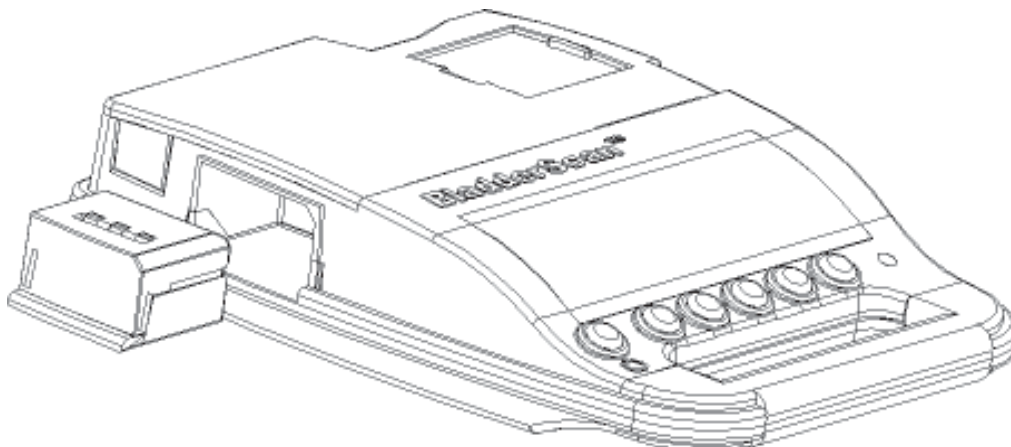

Charging Batteries

***Note:** The battery life is extended if the user waits for about three hours until the battery is fully charged. It is recommended that you keep the spare battery in the charger. There is no danger of over-charging the battery, or having the charger plugged in without the battery.*

Installing a Battery

Battery Icon

The battery-shaped icon is in the upper-right corner of the LCD screen. The battery icon has the following meanings:

Note: The charger will not overcharge the battery. We recommend that you keep one battery in the scanner, the other in the charger, and interchange them daily..



A completely black battery icon means that the battery is fully charged.



A battery icon that is almost full means a partially discharged battery.



A battery icon that is half-black means that the battery is partially discharged. This is the most common display.



A battery icon that is almost empty means that the battery has a very minimal charge. Although a few more scans can still be made, the battery should be charged.



A battery icon that is completely empty means a fully discharged battery. The scanner will not work, and the battery must be charged.

Battery Care

The BVI 3000 draws very little power when it is turned off. However, if you do not plan to use the scanner for several weeks you should remove the battery to keep it from discharging.

The extra battery that is not being used should be left in the charger so it can be kept fully charged.

Operating the BVI 3000

First Time Users: A new operator may want to use the BVI 3000 on a patient with a moderately full bladder, rather than initially attempting to locate a nearly empty bladder. (In addition, an in-service video tape has been sent with your BVI 3000). Viewing the tape will supplement the information in this manual with an actual demonstration.

- Turn the BVI 3000 on by pressing the button above the mark: 

Turning On

When it powers up, the BVI 3000 will test itself and then display the message: “BVI3000.” The screen will also display the customized name, date and time. If the SCAN button is pressed, or if the probe button is pressed the SCAN screen will be displayed.

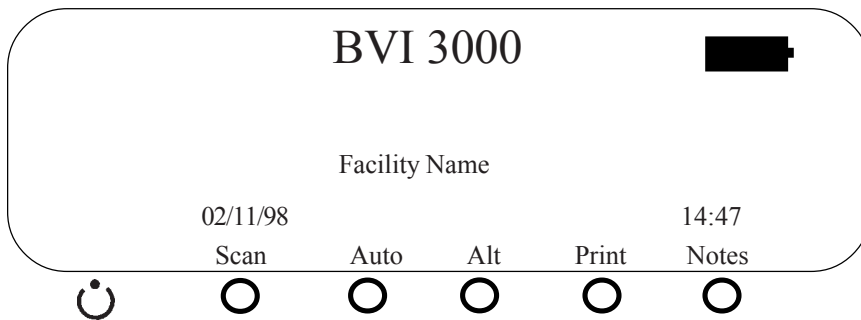

The BVI 3000 allows the patient gender to be selected. If the patient is female, this allows the instrument to exclude the uterus which may resemble the bladder ultrasonically. Use the “MALE” selection if the patient is a female who is known to have undergone a hysterectomy.

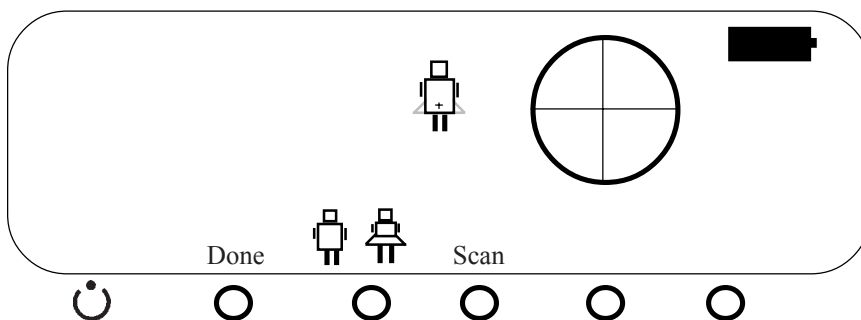

Selecting Gender

- Push the Male/Female button to toggle the gender selection.

Preparing the Scanhead

Clean the rounded end of the scanhead by wiping gently with a cleaning pad dampened with isopropyl alcohol or a hospital disinfectant solution.

Apply an adequate amount of ultrasound transmission gel on the rounded dome of the scanhead. Smooth the gel out and remove any air bubbles which may block transmission.

Scanning the Bladder

Find the symphysis pubis and place the scanhead approximately 3 cm (1 inch) superior to the symphysis pubis and pointing toward the expected bladder location. Locate the patient icon on the scanhead and make sure the head of the icon is pointed toward the head of the patient.

Caution: The presence of a catheter or scar tissue, incisions, sutures or staples from surgery may affect scan accuracy.

Press the scanhead button marked . Hold the scanhead steady until you hear the beep when scanning has been completed. The aiming screen will be displayed.

Note: A scan may also be completed by pressing the SCAN button on the BladderScan unit.

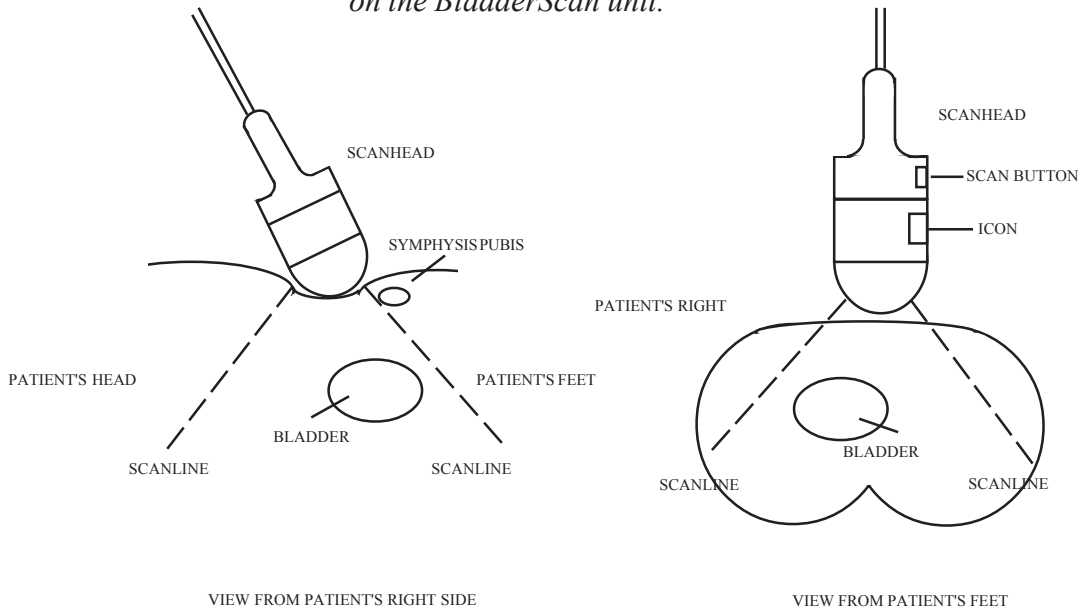

Adjusting Aim

The Aiming screen displays the largest volume measured in the upper left hand corner, the instrument status (ready to scan, scanning and computing), the current volume measurement, and the aiming target.

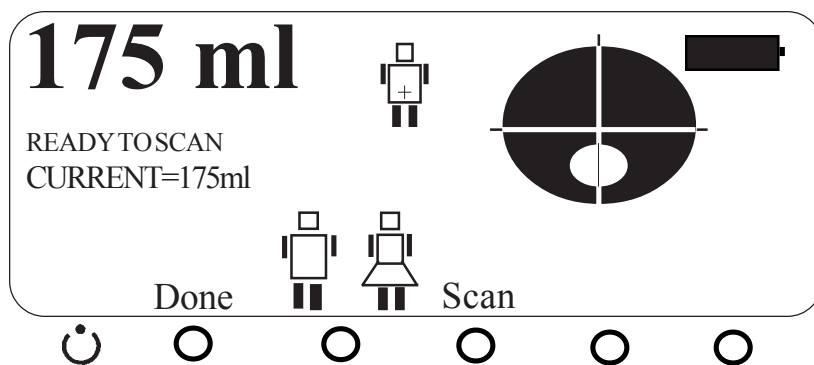

Note: Accuracy is improved when the patient is relaxed in a supine position.

If the crosshairs are not centered on the bladder, adjust the probe and rescan until they are centered. The Aiming screen displays the bladder cross section as viewed when looking down into the patient's abdomen.

When you are satisfied that the aim is correct, press the DONE button. The Scan Results screen will be displayed.

Greater Than Results

Note: In certain cases, the BVI 3000 will display the volume as “>### ml”, where the “###” is the estimated bladder volume. The > (greater than symbol) means that the cone-shaped region scanned by the instrument did not contain the entire bladder, so the true bladder volume may be larger than the displayed volume. The following examples illustrate the possibilities.

Figure 1 shows an aiming screen in which the bladder is completely contained within the scan cone. In this case, the measurement is accurate and the volume is displayed without the > symbol.

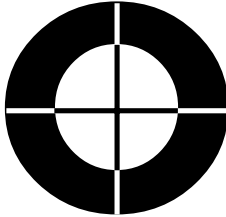

FIGURE 1

Figure 2 shows an aiming screen in which the bladder overlaps one side of the scan cone. The instrument recognizes this condition and displays the > symbol. Greater accuracy will be achieved if the examination is repeated with the scanhead repositioned and reaimed.

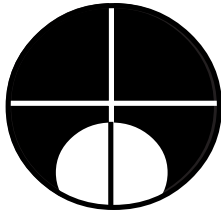

FIGURE 2

Figure 3 shows an aiming screen in which the bladder overlaps two opposite sides of the scan cone. Again the instrument recognizes this condition and displays the > symbol. Since the bladder is too large to be completely contained within the scan cone, repositioning and reposition the scanhead will do little to improve accuracy.

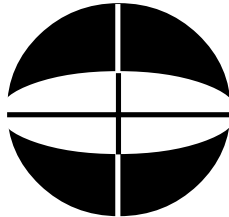
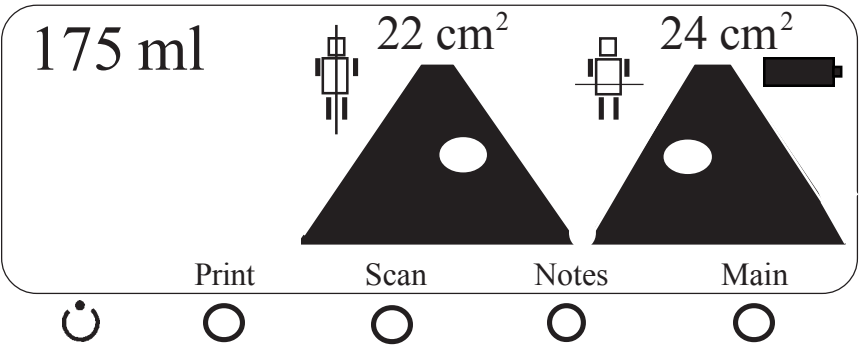

FIGURE 3

The Scan Results screen displays images of the longitudinal and horizontal planes from the largest image found. Each image displays the area of the bladder cross-section of the respective plane and an icon of a man/woman bisected by the scan plane displayed. This screen can be used to evaluate the results of a scan before printing.

Displaying Scan Results



Printing Exam Data

Figure A)





BladderScan(TM)	
User Name (27 Chars Max)	
MM-DD-YY	HH:MM
Bladder Volume=XXXml	
Male/Female Patient Name:	
Patient ID:	
Procedure Code:	
Signature:	
	Longitudinal Axis Area L = XX cm ²
	
	Horizontal Axis Area H = XXcm ²
	

Figure B).

If no printed output is needed, pressing the SCAN button will return to the Scan screen and the instrument will be ready for another scan. Pressing “MAIN” returns to the main menu screen. If a printed output is required, press the PRINT button. The print screen is shown below. Press PRINT to obtain a print out of the most recent exam.

Hardcopy Options

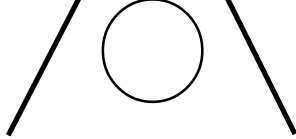
The print menu can be entered either from the main turn on menu or after a scan is done in the scan results menu. The following table describes the various hardcopy output options available to the user. See the tabel on page 11. Use the “SEL” button to select a particular hardcopy output option.

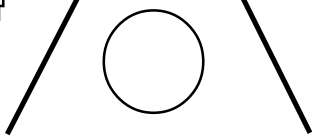
See figure A) on this page and page 12

See figure B) for a histogram on the statistical measurements of your instrument.

Built-In Thermal Printer

Advanced functions you will find in operator’s manual

The BVI 3000 automatically senses the presence of paper and will display “NO PAPER” if the unit is out of paper. The BVI 3000 can also sense when the print head is disengaged and will display “HEAD UP” until the thumb wheel lever is positioned as far up as it can go. Finally, the BVI 3000 will display “TOO HOT” if the print head overheats. Should this message appear shut down the unit and look for a paper jam or some other reason why the print head would be subjected to excessive heat.





Loading Paper

Loading paper into the built-in thermal printer can be done either manually or automatically. The thumb wheel and the print head release lever can be used to manually advance paper through the printing mechanism. To automatically load paper, simply enter the print menu by pressing PRINT at the main turn on menu. The message “NO PAPER” should be displayed. Simply open the paper well door and insert the end of the roll into the paper input slot. The BVI 3000 will sense the presence of the paper and automatically start the paper feed mechanism which will grab the paper and feed it out the paper eject slot in the top of the unit.

PrintOut	<p>ADD_WALLS (default)</p> <p>NO_IMAGES</p> <p>12 PLANES</p> <p>RAW_ONLY</p> <p>WALLS_ONLY</p> <p>TEST PRINT</p>	<p>ADD_WALLS=print grayscale B-mode images with bladder walls highlighted.</p> <p>NO_IMAGES=do not print any B-mode images</p> <p>12 PLANES=print of last measurement; 12 crosssectional images</p> <p>RAW_ONLY=print grayscale B-mode images without identifying bladder walls</p> <p>WALLS_ONLY=bladder outline only</p> <p>This option is only available for the built-in thermal printer. Alpha-numeric characters and a simple grayscale test pattern is printed out. See C), page 11.</p>
-----------------	------------------------------------------------------------------------------------------------------------------	-------------------------------------------------------------------------------------------------------------------------------------------------------------------------------------------------------------------------------------------------------------------------------------------------------------------------------------------------------------------------------------------------------------------------------------------------------------------------------------------------

Figure C)

Quick Start Procedure

1. Make sure that the scanhead is plugged in and a battery is installed.
2. Press the  button to turn the BladderScan on.
3. Press <<1>> (SCAN) button and select the patient gender with the   (MALE/FEMALE) button.
4. Put ultrasound gel on the scanhead, being careful to remove air bubbles.
5. Place the scanhead about 3 cm superior to the symphysis pubis pointing toward the expected bladder location. Make sure the head of the male/female icon on the scanhead is pointed toward the patient's head.
6. Press the scanhead button marked  or <<2>>(SCAN) on the instrument. Hold the scanhead steady until you hear a beep. The BVI 3000 will display the volume measured and an aiming display with crosshairs.
7. If the bladder is not centered on the crosshairs, and also in the case you want to repeat the scanning after pushing <<3>> (DONE), push <<4>> (SCAN). By doing so return to 6. Adjust scanhead and repeat the scan until the bladder is properly centered. The BVI 3000 will save the largest bladder volume from any series of scans.
8. When you are satisfied that the result is accurate, press <<3>>, (DONE) to end the operation. The BVI 3000 will display the largest volume measured and the longitudinal and horizontal scans.
9. For a printed copy of the results, press <<5>> (PRINT), in two screens. The screen hereafter will read: <<8>> (printing in process) In order to abort printing push <<6>>(ABORT). Hereafter, or after printing you may restart (PRINT) <<5> or return to 3, by pushing <<7>> (DONE).
10. For advanced functions or options contact your distributor.

Proper Care and Maintenance

The BVI 3000 may be cleaned with a soft cloth dampened in isopropyl alcohol or any standard hospital cleaning solution that does not contain aromatic hydrocarbons.

The round, black, plastic dome of the scanhead that contacts the patient may be disinfected with any disinfecting agent suitable for use with LEXAN polycarbonate. Follow the instructions provided by the manufacturer of the disinfecting agent. Do not immerse the scanhead beyond the point at which the black plastic dome connects to the black metal body. Do not use Cidex Plus, as it is not recommended for use with LEXAN polycarbonate.

Do not subject any part of the BVI 3000 to steam sterilization or ethylene oxide sterilization.

This device is a measurement device of which the accuracy may be impacted by abuse or material defects. Therefore the system needs a periodic inspection, at least once a year. Please contact your local distributor which will be able to provide the necessary service.

The manufacturer recommends that users perform the following checks approximately once per week. This will ensure that the instrument operates properly and safely at all times.

- Inspect the scanhead for cracks that could allow the ingress of conductive fluid and inspect the cable and connector for any apparent physical fault. If any such problem is suspected, disconnect faulty probe and replace with a known good probe. Return faulty probe to DxU Customer Service for repair or replacement warranty conditions apply.

Compare prevoid and postvoid measurements with the voided volume

- measured in an accurate beaker. Results should be consistent with the statement of accuracy in “Technical Description.”

Cleaning and Disinfection



Calibration Inspection

Caution: *In the event of changes in the performance of the instrument, discontinue use and contact the manufacturer.*

Trouble Shooting

No Probe Message

The BVI 3000 also determines if the correct scanhead is connected. If the correct scanhead is installed, the instrument will proceed to the normal powerup state. If no scanhead or an incorrect scanhead is installed, the BVI 3000 will display: “NO PROBE”, if scan is pushed.

Recharge Message

When the battery charge is too low to allow normal operation but not too low to permit operation of the internal circuitry, a recharge screen will be displayed reading: “BATTERY CHARGE LEVEL IS TOO LOW FOR INSTRUMENT OPERATION. RECHARGE BEFORE NEXT USE.” In such cases the battery must be recharged.

Clearing Paper Jam

If the paper tape will not feed, lower the print head release lever located adjacent to the paper advance thumb wheel. Gently pull the paper either forward or backward to clear the paper jam.

Caution: If the paper jam is inaccessible do not try to disassemble the printer. Return the instrument to the manufacturer for service.

Battery Appears Dead

Most scanner problems are due to a discharged battery and can be fixed by simply replacing the battery with a freshly charged one. Check the battery icon in the upper-right corner of the scanner’s LCD screen. If the battery icon is not darkened, replace the battery with a freshly charged one to see if that solves the problem.

Warranty

DxU Europe warrants the BVI 3000 against defects in material and workmanship. In principle this warranty applies for 1 (one) year from the date of purchase from DxU Europe. This warranty is given only to the original purchaser of the BVI 3000

DxU reserves the right to offer you a different guarantee period. Pursuant to this warranty, DxU Europe will repair or replace products which prove to be defective during the warranty period, provided that the repair is performed by Diagnostic Ultrasound or a Diagnostic Ultrasound authorized service organization, and the instrument is returned to DxU Europe for service.

In some countries, this warranty statement is for information only. Specific warranty terms may be found in the sales contract.

Disclaimer of Additional Warranties

The information, descriptions, recommendations, and safety notations in this *Short Operator’s Manual* are based upon DxU Europe experience and judgement, as of 1998, with respect to the BVI 3000.

Customer is expected to have good knowledge about (own language) Short Operator’s Manual and extended (English language) Operator’s Manual

Safety and Performance Summary

- The BVI 3000 computes the volume of the bladder based upon twelve cross sectional images of the bladder. Be sure to hold the scanhead motionless during scans.
- The most accurate measurements are obtained when the patient is resting quietly in the supine position.
- The accuracy of the result is compromised if the user does not obtain an optimal, repeatable image.
- Errors in usage tend to result in underestimation of bladder volume except in cases where the scanhead is moved while scanning is taking place.
- Use care with suprapubic and pelvic surgical patients, and open skin patients.
- To save power, the BVI 3000 will turn itself off when not in use.
- Diagnostic Ultrasound recommends that the new user first use the BVI 3000 on a patient with a moderately full bladder, rather than initially attempting to locate a bladder with a low volume.
- Warning: There is a possible explosion hazard if the BVI 3000 is used in the presence of flammable anesthetics.



BVI 3000 Components

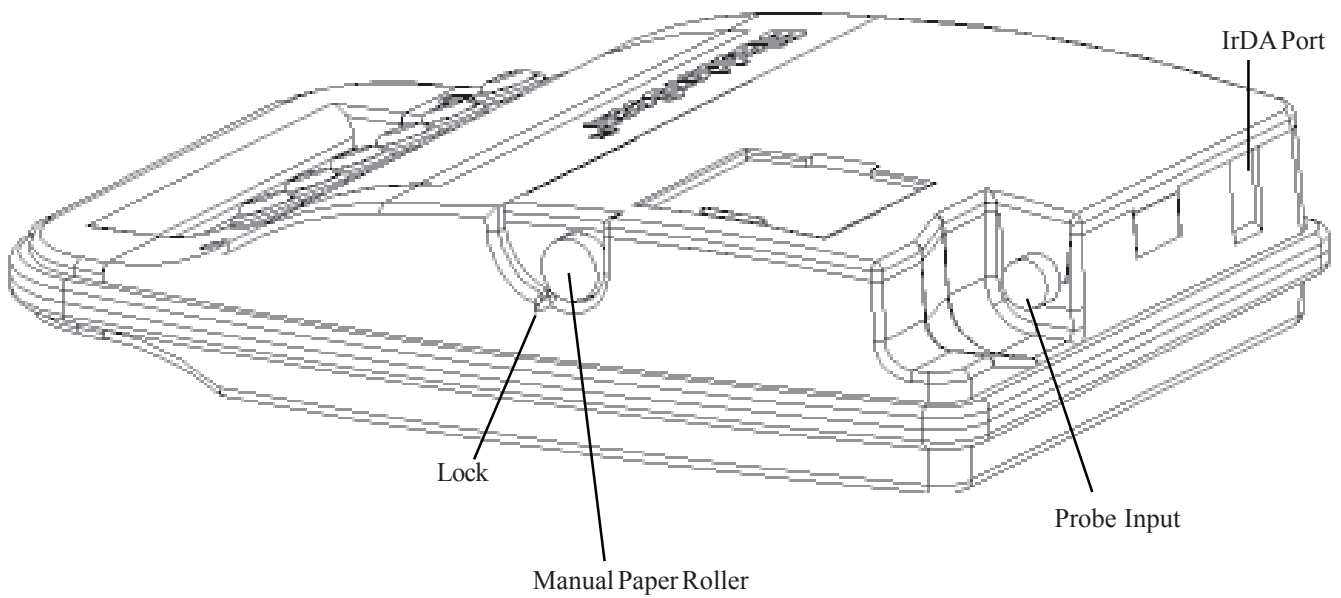
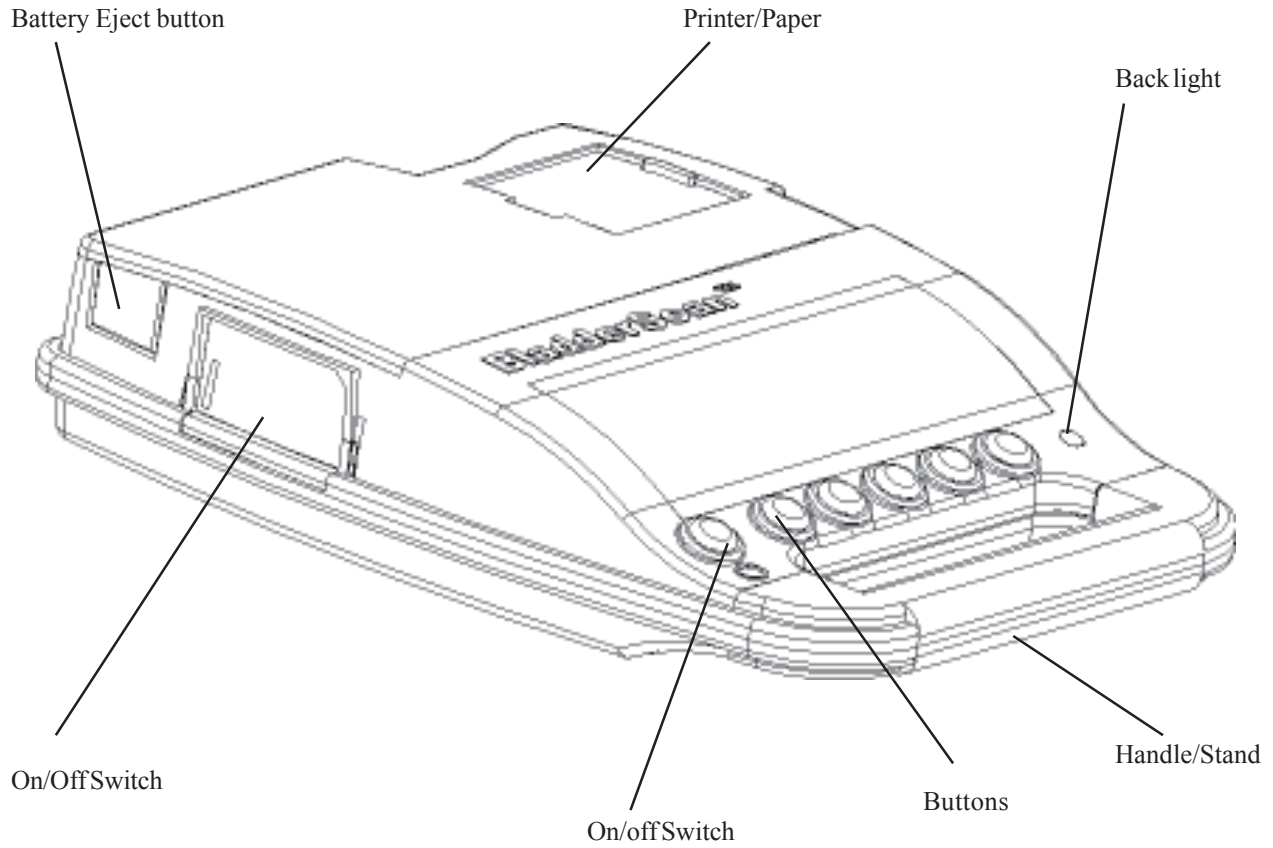

Parts and Accessories

Quantity	Part Number	Description
1	570-0090	Control Unit
1	570-0091	Dome Scanhead Assembly
1	570-0096	Flat Scanhead Assembly
1	400-0036	Battery Charger
1	800-0004	Scanhead Holder
1	800-0005	Acoustic Coupling Gel, 0.25 liter
1	570-0095	Computer IrDA Interface "Woosh"
1	400-0039	Battery Pack 7.2V
3	800-0042	Printer Paper
1	900-0383	Operator's Manual

Technical Description

Scanning Accuracy

Given the tremendous variation of healthy and compromised human anatomy, a guaranteed accuracy specification for the instrument used on humans would be difficult. For this reason, the following accuracy specification assumes usage per instructions, scanning a DxU Tissue Equivalent Phantom:

Bladder Volume Range:	0 to 999 ml
Accuracy:	0 to 699 ml $\pm 20\%$, ± 20 ml
	700 to 999 ml $\pm 25\%$, ± 25 ml

Note: The accuracy that an individual achieves using the BVI 3000 will depend on properly aiming the sensor so that the bladder falls entirely within the measurement cone.

Environmental

Ambient temperature from -20 to +60 degrees Celsius

Conditions for

Relative humidity of 20% to 95%, non-condensing

Storage

Atmospheric pressure from 500 hPa to 1060 hPa

Environmental

Ambient temperature from +10 to +40 degrees Celsius

Conditions for Use

Relative humidity of 30% to 75%, non-condensing

Atmospheric pressure from 700hPa to 1060 hPa

Battery Charger

The battery charger DxU No. 400-0036 can be used with an input of 100-250V~ sat 47 to 63 Hz. Its output is 9v at 1Amp.

Use only the battery charger supplied. Use of any other charger may damage the battery pack.



The manufacturer certifies that the BladderScan™ BVI 3000 complies with the Essential Requirements of Annex I of the Medical Device Directive 93/42/EEC. This certification includes compliance with the Electromagnetic Compatibility Directive 89/336/EEC.

The manufacturer has been certified to be in conformity with the requirements of the Medical Device Directive 93/42/EEC Annex II Section 3, EN 29001 (ISO 9001), and EN 46001 by the Notified Body TÜV Product Service GmbH (#0123).